

User manual

Tumble dryer

TE1120HP
PNC 916098429



Electrolux
PROFESSIONAL

Contents

Contents

1	Safety Information	5
1.1	Children and vulnerable people safety	5
1.2	Installation.....	6
1.3	Electrical connection	7
1.4	Use.....	8
1.5	Internal lighting	9
1.6	Care and cleaning.....	9
1.7	Compressor	9
1.8	Service	9
1.9	Disposal.....	10
2	Warranty terms and exclusions.....	11
3	Product description.....	12
4	Accessories	13
4.1	Stacking kit.....	13
4.2	Draining kit.....	13
4.3	Pedestal with the drawer	13
5	Control panel	14
5.1	Display.....	14
6	Programs.....	15
7	Options.....	16
7.1	Half load	16
7.2	Extra dry	16
7.3	Cupboard dry	16
7.4	Iron dry	16
7.5	Care	16
7.6	Time	16
8	Before first use.....	16
9	Daily use	17
9.1	Preparing the laundry	17
9.2	Loading the laundry	17
9.3	Turning on the appliance	18
9.4	Auto Off function	18
9.5	Setting a program	18
9.6	Options	18
9.7	Starting a program	19
9.8	Program change.....	19
9.9	Program end	19
10	Hints and tips	20
10.1	Ecological hints.....	20
10.2	Adjustment of the remaining laundry moisture degree.....	20
10.3	Deactivating the Reservoir indicator	20
11	Care and cleaning	21
11.1	Cleaning the filter.....	21
11.2	Emptying the water container.....	22
11.3	Cleaning the condenser.....	23
11.4	Cleaning the humidity sensor.....	24
11.5	Cleaning the drum.....	24
11.6	Cleaning the control panel and housing	25
11.7	Cleaning the airflow slots.....	25
12	Trouble shooting	26
13	Technical data.....	27
13.1	Product information sheet in reference to E.U. regulation 1369/2017	28
14	Disposal information	29
14.1	Disposal of appliance at end of life	29
14.2	Disposal of packing.....	29

The manufacturer reserves the right to make changes to design and component specifications.

1 Safety Information

Before beginning the installation and use of this appliance, carefully read the supplied instructions. The manufacturer is not responsible for any injuries or damage that are the result of incorrect installation or usage. Always keep the instructions in a safe and accessible location for future reference.



Read the instructions before using the machine

1.1 Children and vulnerable people safety



Warning



Risk of suffocation, injury or permanent disability.

- This appliance can be used by children aged from 8 years and above and persons with reduced physical, sensory or mental capabilities or lack of experience and knowledge if they have been given supervision or instruction concerning the use of the appliance in a safe way and understand the hazards involved.
- Children between 3 and 8 years of age and persons with very extensive and complex disabilities shall be kept away from the appliance unless continuously supervised.
- Children of less than 3 years of age should be kept away from the appliance unless continuously supervised.
- Do not let children play with the appliance.
- Keep all packaging away from children and dispose of it appropriately.
- Keep detergents away from children.
- Keep children and pets away from the appliance when the door is open.
- If the appliance has a child safety device, it should be activated.
- Children shall not carry out cleaning and user maintenance of the appliance without supervision.

1.2 Installation

- This appliance is for household and commercial use.
- Remove all the packaging.
- Do not install or use a damaged appliance.
- Follow the installation instructions supplied with the appliance.
- Always take care when moving the appliance as it is heavy. Always use safety gloves and enclosed footwear.
- Do not install or use the appliance where the temperature is less than 5°C or higher than 35°C.
- The floor area on which the appliance is to be installed must be flat, stable, heat resistant and clean.
- Make sure that there is air circulation between the appliance and the floor.
- Always keep the appliance vertical when it is being moved.
- Make sure that the appliance is stable during transportation.
- The appliance can be installed as freestanding or below the kitchen counter with correct space (Refer to the Installation leaflet).
- If the tumble dryer is put on top of a washing machine, use the stacking kit. The stacking kit, available from your authorized vendor, can be used only with the appliance specified in the instructions, supplied with the accessory. Read it carefully before installation (Refer to the Installation leaflet).
- Do not install the appliance behind a lockable door, a sliding door or a door with a hinge on the opposite side, that would prevent the appliance door from being fully open.
- Do not install the appliance in a moving platform (e.g. on a ship).
- The rear surface of the appliance must be put against the wall.
- When the appliance is in its permanent position, check if it is levelled correctly with the aid of a spirit level. If it is not, adjust the feet accordingly.
- Make sure that the appliance is disconnected from the electricity supply during installation, maintenance and repairs and cannot be reconnected until all work has been carried out.
- Connect the mains plug to the mains socket only at the end of the installation process. Make sure that the mains plug is accessible after installation.
- Ensure good air ventilation in the room where the appliance is installed to avoid the backflow of unwanted gases into the room from appliances burning gas or other fuels, including open fires.
- Exhaust air must not be discharged into a flue which is used for exhausting fumes from any appliances burning gas or other fuels.
- **WARNING:** Keep ventilation openings clear of obstruction in the appliance enclosure or in the built-in structure.
- The ventilation opening in the base must not be covered by a carpet, mat, or any floor covering.

1.3 Electrical connection



Warning



Risk of fire and electric shock.

- The appliance must be correctly earthed. The manufacturer is not responsible for the consequences of an inadequate earthing system.
- Make sure that the parameters on the rating plate are compatible with the electrical ratings of the mains power supply.
- **WARNING:** The appliance must not be supplied through an external switching device, such as a timer, or connected to a circuit that is regularly switched on and off by a utility.
- Always use a correctly installed shockproof socket.
- Do not use multi-plug adapters and extension cables.
- Do not pull the mains cable to disconnect the appliance. Always pull the mains plug.
- Do not touch the mains cable or the mains plug with wet hands.
- If the mains power supply cable is damaged, it must be replaced by the manufacturer, its Authorized Service Centre or similarly qualified persons to avoid an electrical hazard.
- This appliance is fitted with a 13 A mains plug. If it is necessary to change the mains plug fuse, use only a 13 A ASTA (BS 1362) fuse (UK and Ireland only).

1.4 Use



Warning



Risk of injury, electric shock, fire, burns or damage to the appliance.

- Obey the maximum load volume of 8.0 kg (refer to the “Programs” chapter).
- Do not change the specification of the appliance.
- Do not use the appliance if items have been soiled with industrial chemicals.
- Wipe away lint or packaging debris that has accumulated around the appliance.
- Do not run the appliance without a filter. Clean the lint filter before or after each use.
- Do not dry unwashed items in the tumble dryer.
- **WARNING:** Do not damage the refrigerant circuit.
- Items that have been soiled with substances such as cooking oil, acetone, alcohol, petrol, kerosene, spot removers, turpentine, waxes and wax removers should be washed in hot water with an extra amount of detergent before being dried in the tumble dryer.
- Items such as foam rubber (latex foam), shower caps, waterproof textiles, rubber backed articles and clothes or pillows fitted with foam rubber pads should not be dried in the tumble dryer.
- Fabric softeners, or similar products, should only be used as specified by the product manufacturer’s instructions.
- Remove all objects from items that could be a source of fire ignition such as lighters or matches.
- **WARNING:** Never stop a tumble dryer before the end of the drying cycle unless all items are quickly removed and spread out so that the heat is dissipated.
- The final part of a tumble dryer cycle occurs without heat (cool down cycle) to ensure that the items are left at a temperature that ensures that the items will not be damaged.
- Do not dry damaged (torn, frayed) items that contain padding or fillings.
- Dry only fabrics that are suitable to dry in the appliance. Follow the cleaning instruction on the item label.
- If laundry has been washed with a stain remover, carry out an additional rinse cycle before starting a drying cycle.
- Do not drink or prepare food with the condensed water/ distilled water. It can cause health problems to people and pets.
- Do not sit or stand on the open door of the appliance.
- Do not dry dripping wet clothes in the appliance.

1.5 Internal lighting



Warning



Risk of injury.

- Concerning the lamp(s) inside this product and spare part lamps sold separately: These lamps are intended to withstand extreme physical conditions in household appliances, such as temperature, vibration, humidity, or are intended to signal information about the operational status of the appliance. They are not intended to be used in other applications and are not suitable for household room illumination.
- Visible LED radiation, do not look directly into the beam.
- To replace the internal lighting, contact the Authorized Service Centre.

1.6 Care and cleaning



Warning



Risk of injury or damage to the appliance.

- Do not use water spray and steam to clean the appliance.
- Clean the appliance with a moist soft cloth. Use only neutral detergents. Do not use abrasive products, abrasive cleaning pads, solvents or metal objects.

1.7 Compressor



Warning



Risk of damage to the appliance.

- The compressor and its system in the tumble dryer is filled with the special agent which is free from fluorochlorohydrocarbons. This system must stay tight. The damage of the system can cause a leakage.

1.8 Service

- Only authorized spare parts, accessories and consumables shall be used.
- For optimal performance, the heat pump module must be replaced by an authorized technician every 2500 cycles.

1.9 Disposal



Warning



Risk of injury or suffocation.

- Disconnect the appliance from the mains electrical and water supplies.
- Cut off the mains electrical cable close to the appliance and dispose of it.
- Remove the door catch to prevent children or pets from becoming trapped in the drum.

2 Warranty terms and exclusions

If the purchase of this product includes warranty coverage, warranty is provided in line with local regulations and subject to the product being installed and used for the purposes as designed, and as described within the appropriate equipment documentation.

Warranty will be applicable where the customer has used only genuine spare parts and has performed maintenance in accordance with Electrolux Professional user and maintenance documentation made available in paper or electronic format.

Electrolux Professional strongly recommends using Electrolux Professional approved cleaning, rinse and descaling agents to obtain optimal results and maintain product efficiency over time.

The Electrolux Professional warranty does not cover:

- service trips cost to deliver and pick up the product;
- installation;
- training on how to use/operate;
- replacement (and/or supply) of wear and tear parts unless resulting from defects in materials or workmanship reported within one (1) week from the failure;
- correction of external wiring;
- correction of unauthorized repairs as well as any damages, failures and inefficiencies caused by and/or resulting from;
 - insufficient and/or abnormal capacity of the electrical systems (current/voltage/frequency, including spikes and/or outages);
 - inadequate or interrupted water supply, steam, air, gas (including impurities and/or other that does not comply with the technical requirements for each appliance);
 - plumbing parts, components or consumable cleaning products that are not approved by the manufacturer;
 - customer's negligence, misuse, abuse and/or non-compliance with the use and care instructions detailed within the appropriate equipment documentation;
 - improper or poor: installation, repair, maintenance (including tampering, modifications and repairs carried out by third parties not authorized third parties) and modification of safety systems;
 - Use of non-original components (e.g.: consumables, wear and tear, or spare parts);
 - environment conditions provoking thermal (e.g. overheating/freezing) or chemical (e.g. corrosion/oxidation) stress;
 - foreign objects placed in- or connected to- the product;
 - accidents or force majeure;
 - transportation and handling, including scratches, dents, chips, and/or other damage to the finish of the product, unless such damage results from defects in materials or workmanship and is reported within one (1) week of delivery unless otherwise agreed;
- product with original serial numbers that have been removed, altered or cannot be readily determined;
- replacement of light bulbs, filters or any consumable parts;
- any accessories and software not approved or specified by Electrolux Professional.

Warranty does not include scheduled maintenance activities (including the parts required for it) or the supply of cleaning agents unless specifically covered within any local agreement, subject to local terms and conditions.

Check on Electrolux Professional website the list of authorized customer care.

3 Product description

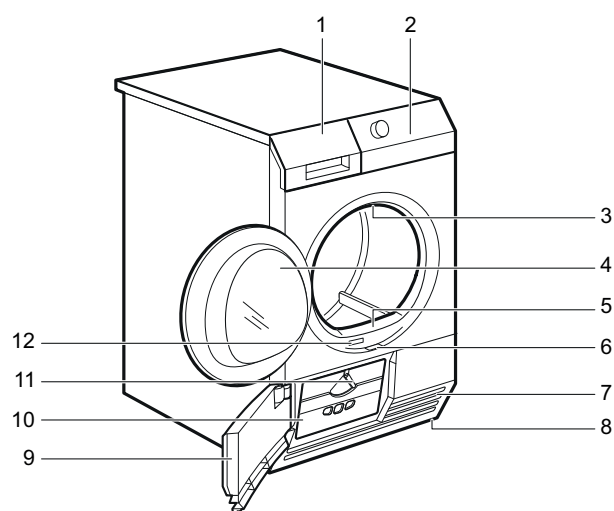

fig.X02242

1	Water container
2	Control panel
3	Internal light
4	Appliance door
5	Filter
6	Button to open the heat exchanger door
7	Airflow slots
8	Adjustable feet
9	Heat exchanger door
10	Heat exchanger cover
11	Knob to lock the heat exchanger cover
12	Rating plate

For ease of loading laundry or ease of installation the door is reversible. (See separate leaflet).

4 Accessories

4.1 Stacking kit

It is available from your authorized vendor. Stacking kit can be used only with the washing machines specified in the leaflet. See the leaflet attached. Read carefully the instructions supplied with the accessory.

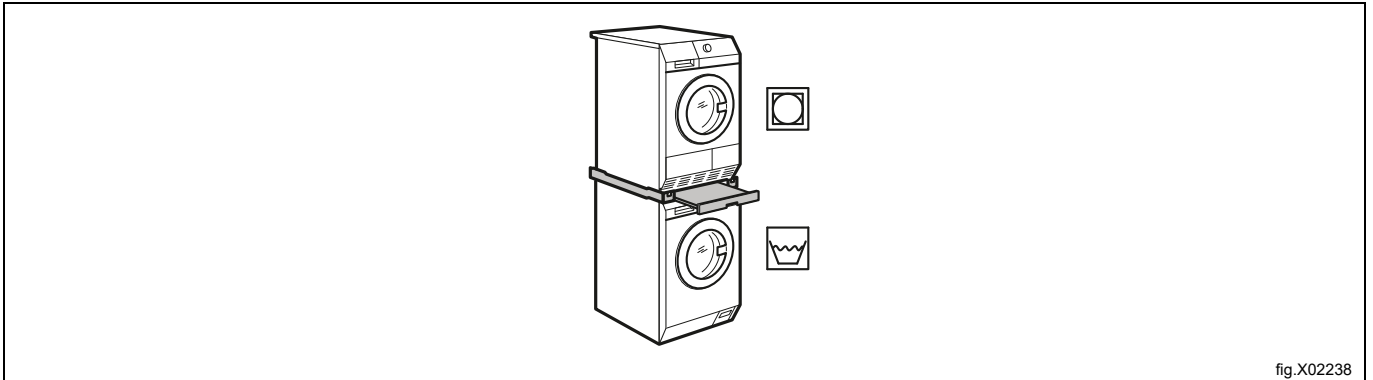

4.2 Draining kit

It is available from your authorized vendor (can be attached to some types of the tumble dryers).

The accessory for through draining of the condensed water into a basin, siphon, gully, etc. After the installation, the water container is drained automatically. The water container must stay in the appliance.

The installed hose must be on the height from minimum of 50 cm to maximum of 1 m from floor level. The hose cannot be in loop. Decrease the length of the hose if necessary.

Read carefully the instructions supplied with the accessory.

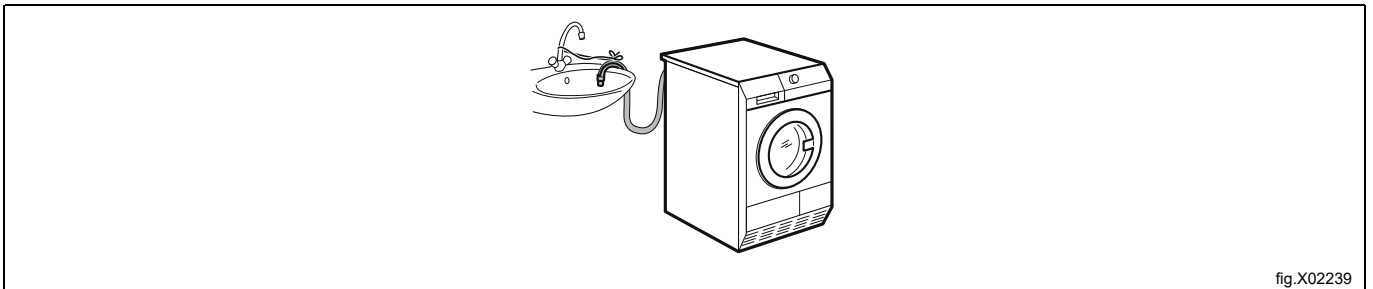

4.3 Pedestal with the drawer

It is available from your authorized vendor.

To put the appliance higher at the level what helps to easy load and remove the laundry.

The drawer can be used for laundry storage e.g. : towels, cleaning products and more.

Read carefully the instructions supplied with the accessory.

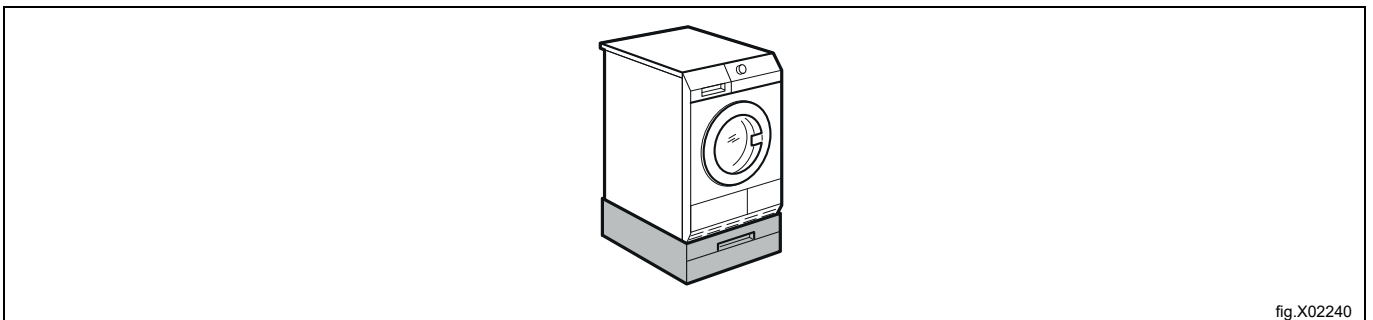

5 Control panel

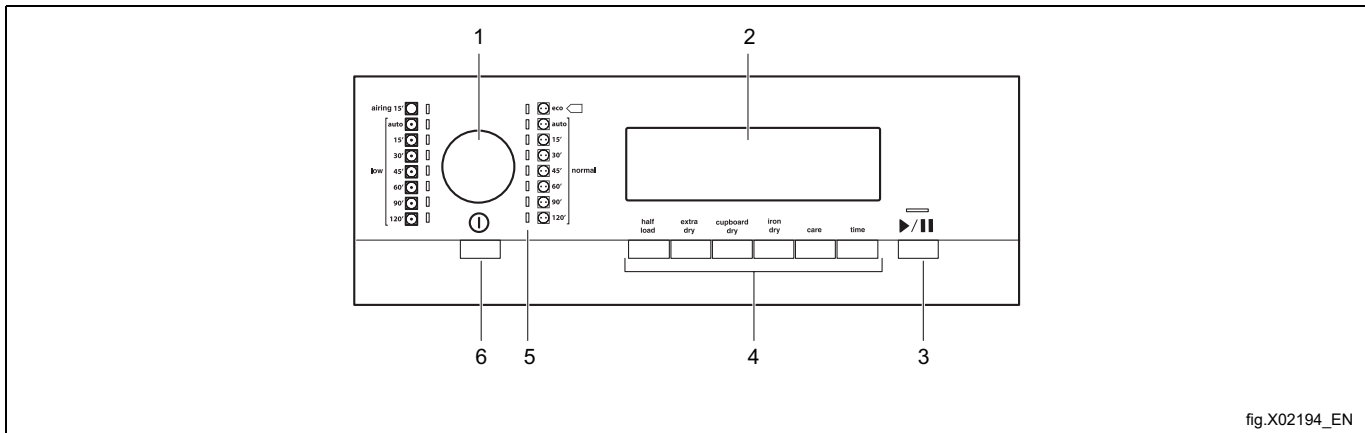

fig.X02194_EN

1	Program dial
2	Display
3	Start/Pause button
4	Options buttons
5	Program indicators
6	ON/OFF button with the Auto Off function

5.1 Display

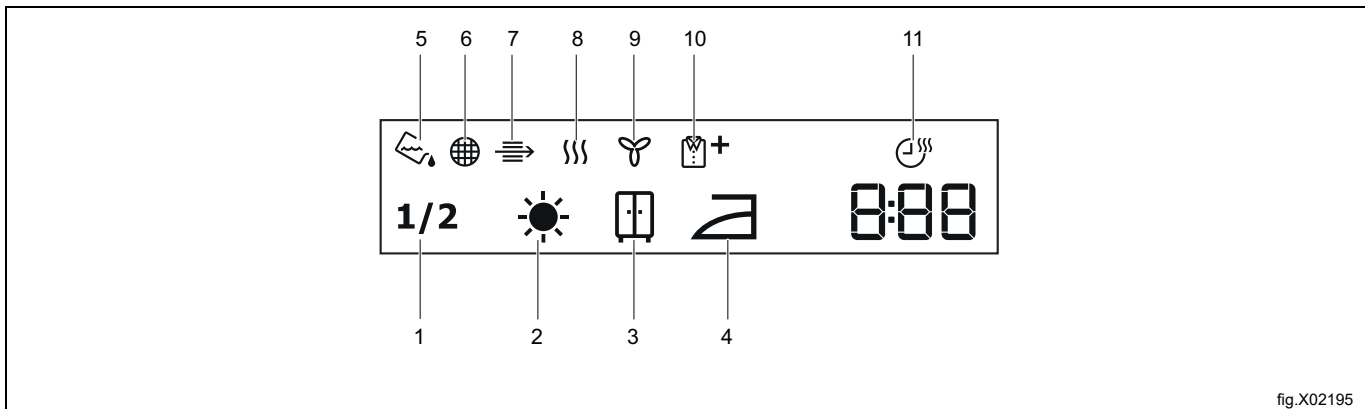

fig.X02195



Symbol on the display	Symbol description
1	Half load
2	Dryness - extra dry
3	Dryness - cupboard dry
4	Dryness - iron dry
5	Indicator: drain the water container
6	Indicator: clean filter
7	Indicator: do the check of the heat exchanger
8	Indicator: drying phase
9	Indicator: cooling phase
10	Indicator: crease guard phase
11	Time dry option on
2 . 00	Cycle time indication
1 . 20	Time selection (5 min. steps)

6 Programs

There are two types of programs, automatic programs and time programs.



- Automatic programs has moisture detection and will stop when selected dryness is achieved.
- Time programs has no moisture detection and will stop when the preset or selected time has ended.

The following table shows the available programs and a short description of those:

Automatic programs		Maximum load*	Description
	Eco	8.0 kg	Cotton and terry - most efficient in terms of energy consumption. Normal/medium temperature. The program will stop when preset dryness/selected option is achieved. (Extra dry, Cupboard dry, Iron dry).
	Normal	8.0 kg	Cotton and terry. Normal/medium temperature. The program will stop when preset dryness/selected option is achieved. (Extra dry, Cupboard dry, Iron dry).
	Low	3.5 kg	Synthetic (example of synthetic fabrics: polyester, polyamide, polyacrylic and elasthan), viscose, polycotton and delicate fabrics. Low temperature. The program will stop when preset dryness/selected option is achieved. (Extra dry, Cupboard dry, Iron dry).

* The maximum weight of the load refers to dry items.

** The  Cotton Eco program is the “Standard cotton program” according to Commission Regulation EU No. 392/2012. It is suitable for drying normal wet cotton laundry and it is the most efficient programme in terms of energy consumption for drying wet cotton laundry.

Time programs		Description
	Normal	Cotton and terry. Different drying times can be selected. The program will stop when the time is up.
	Low	Synthetic (example of synthetic fabrics: polyester, polyamide, polyacrylic and elasthan), viscose, polycotton and delicate fabrics. Different drying times can be selected. The program will stop when the time is up.
	Airing	Airing bedspreads, duvets and bedclothes. The program will stop when the time is up.

7 Options

7.1 Half load

Use this option if you dry half load of the laundry.

7.2 Extra dry

This option helps to get the laundry extra dried.

7.3 Cupboard dry

This option assure that the laundry after drying process is ready to store.

7.4 Iron dry

This option assure that the laundry after drying process is suitable to iron.

7.5 Care

Extends anti-crease phase (30 minutes) at the end of the drying cycle to 90 minutes. This option prevents laundry from creases. Laundry can be removed during the anti-crease phase.

7.6 Time

This allows the user to increase time of drying in steps of 5 minutes.

8 Before first use

Rear drum locks are removed automatically when the dryer is activated for the first time. Possible to hear some noise.

To unlock the rear drum locks:

1. Switch on the appliance.
2. Set any program.
3. Press the **Start/Pause** button. Drum starts to rotate. Rear drum locks are deactivated.

Before you use the appliance for the first time do these operations:

- Clean the tumble dryer drum with a moist cloth.
- Start a 1 hour program with moist laundry.

At the beginning of the drying cycle (first 3-5 min) there could be a slightly higher sound level. This is due to the compressor starting up. This is normal for compressor powered appliances such as refrigerators and freezers.

9 Daily use





9.1 Preparing the laundry

Note!

Very often the clothes after washing cycle are kneaded and tangled altogether. Drying kneaded and tangled clothes is inefficient. To assure proper air flow and even drying it is recommended to shake and load one by one the clothes to the tumble dryer.

To assure proper drying process:

- Close the zips.
- Close the fasteners of the duvet covers.
- Do not keep ties or ribbons loose (e.g. apron ribbons). Tie them before you start a program.
- Remove all items from pockets.
- Turn items with the internal layer made of cotton inside out. Cotton layer must be faced outwards.
- Always set the programme suitable for the type of laundry.
- Do not put light and dark colors together.
- Use suitable programme for cottons, jersey and knitwear to reduce shrinkage.
- Do not exceed the maximum load stated in the programs chapter or shown on the display.
- Dry only the laundry that is suitable for tumble drying. Refer to the fabric label on the items.
- Do not dry large and small items together. Small items can be trapped inside the large items and remain wet.
- Shake the large clothes, fabrics before placing in the tumble dryer. It is to avoid moist places inside the fabric after the drying cycle.

Fabric label	Description
	Laundry is suitable for tumble drying.
	Laundry is suitable for tumble drying at higher temperatures.
	Laundry is suitable for tumble drying at low temperatures only.
	Laundry is not suitable for tumble drying.

9.2 Loading the laundry



Caution



Ensure the laundry is not trapped between the appliance door and the rubber seal.

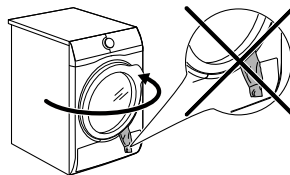

fig.X03358

1. Pull open the appliance door.
2. Load the laundry one item at a time.
3. Close the appliance door.

9.3 Turning on the appliance

To turn on the appliance:

- Push the **ON/OFF** button. If the appliance is on, some indications come in to the view on the display.

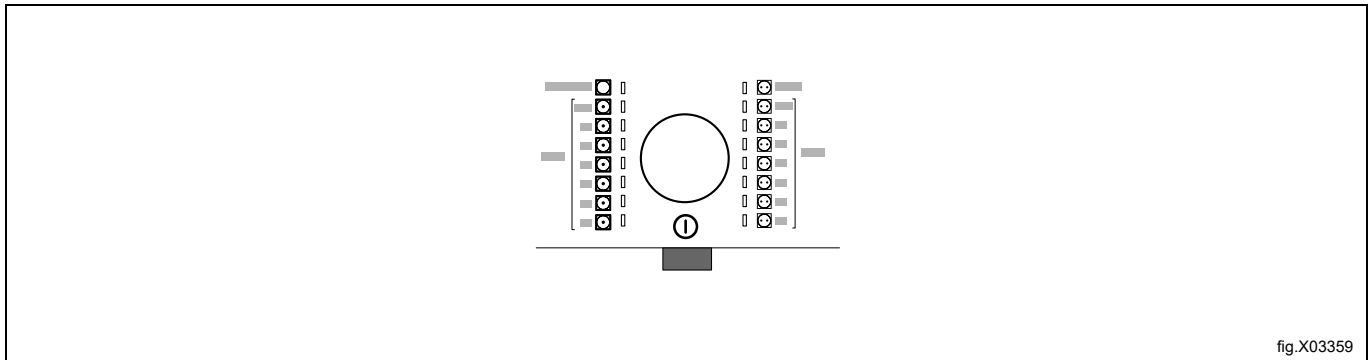

fig.X03359

9.4 Auto Off function

To decrease the energy consumption, the **Auto Off** function turns the appliance off automatically:

- If the **Start/Pause** button is not touched within 5 minutes.
- 5 minutes after a cycle ends.

Push the **ON/OFF** button. If the appliance is on, some indications come in to the view on the display.

9.5 Setting a program

Use the program dial to set the program. The time to the program end comes into the view on the display.

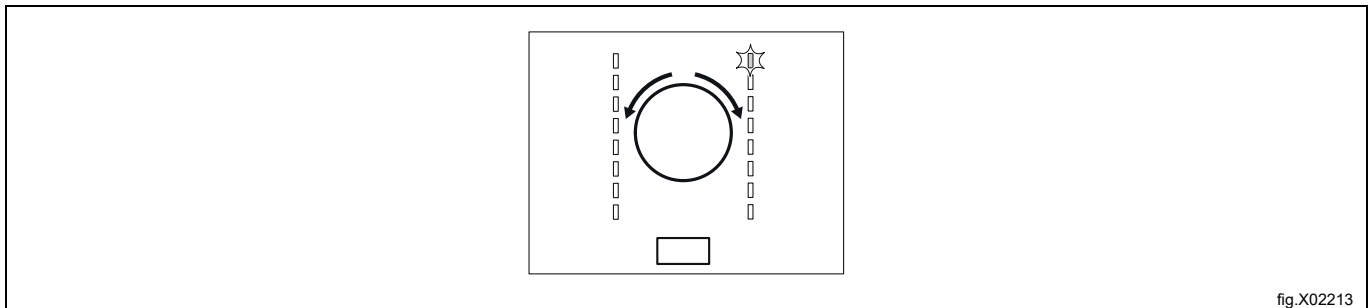

fig.X02213

9.6 Options

Together with the program you can set one or more special options.

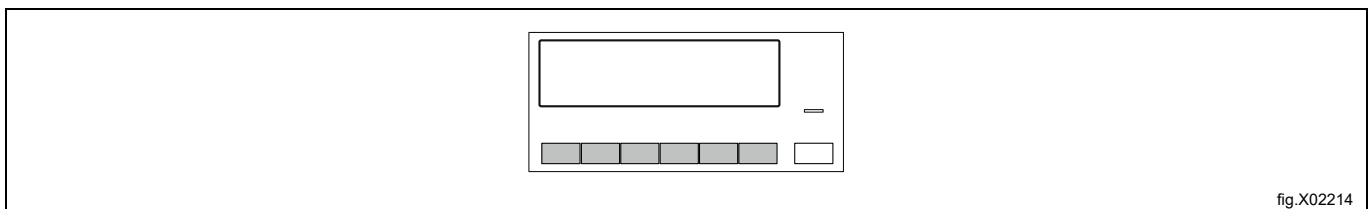

fig.X02214

To activate or deactivate an option touch the relevant button or a two button combination. Its symbol appears on the display or the led above the corresponding button lights up.

9.7 Starting a program

To start the program:

- Touch the **Start/Pause** button.
- The appliance starts and the LED above the button stops flashing and stays on.

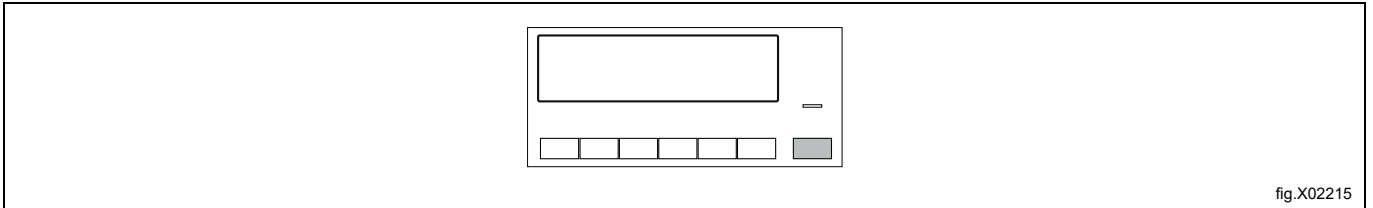

fig.X02215

9.8 Program change

To change a program:

1. Push the **ON/OFF** button to turn the appliance off.
2. Push the **ON/OFF** button again to turn on the appliance.
3. Set a new program.

9.9 Program end

Clean the filter and drain the water container after each drying cycle.

If the drying cycle is completed, the symbol  flashes on the display and the acoustic signal sounds intermittently for 1 minute.

If you do not turn off the appliance, the crease guard phase starts. Laundry can be removed during this phase.

To remove the laundry:

1. Push the **ON/OFF** button for 2 seconds to turn off the appliance.
2. Open the appliance door.
3. Remove the laundry.
4. Close the appliance door.

10 Hints and tips

10.1 Ecological hints

- Spin the laundry well before drying.
- Do not exceed the load sizes which are specified in the programs chapter.
- Clean the filter after each drying cycle.
- Do not use fabric softener to wash and then dry. In the tumble dryer laundry becomes soft automatically.
- The water from the water container can be used to iron the clothes. You must first filter the water to eliminate remaining textile fibres (simple coffee filter is suitable).
- Always keep the airflow slots at the bottom of the appliance clear.
- Make sure there is good airflow where the appliance is to be installed.

10.2 Adjustment of the remaining laundry moisture degree

To change the default degree of the remaining moisture of the laundry:

1. Turn on the appliance.
2. Wait approximately 8 seconds.
3. Select one of available programs.
4. Push at the same time and hold down the Half load and Cupboard dry buttons.

One of the symbols goes into the view on the display:

 - the maximum dry laundry

 - the more dry laundry

 - the standard dry laundry

5. Push the **Start/Pause** button again and again until you set necessary degree.
6. To memorise the setting, push at the same time the Half load and Cupboard dry buttons for approximately 2 seconds.



10.3 Deactivating the Reservoir indicator

The water container indicator is by default on. It starts to light at the end of the drying cycle or during the cycle if the water reservoir is full. If the draining kit is installed the water container is drained automatically and indicator can be permanently off.

To deactivate the indicator:

1. Turn on the appliance.
2. Wait approximately 8 seconds.
3. Select one of available programs.
4. Push at the same time and hold down the Half load and Iron dry buttons.

One of two configurations is possible:

- The Reservoir indicator is on and the symbol  goes into the view - the water container indicator is permanently on.
- The Reservoir indicator is off and the symbol  goes into the view - the water container indicator is permanently off.

11 Care and cleaning

11.1 Cleaning the filter

At the end of each cycle the symbol  **Filter** appears on the display indicating that you must clean the filter.

The filter collects the lint during the drying cycle.

To achieve the best drying performances clean the filter regularly, clogged filter lead to longer cycles and energy consumption increase. Use your hand to clean the filter and if necessary, a vacuum cleaner.



Caution



Avoid the use of water to clean the filter. Instead throw away lint in the dustbin (avoid dispersion of plastic fiber in water ambient).

To clean the filter:

1. Open the door. Pull the filter up.

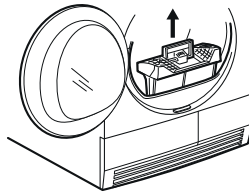

fig.X02224

2. Push the hook to open the filter.

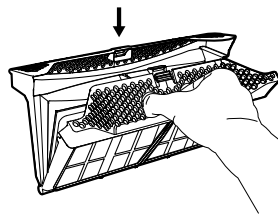

fig.X02247

3. Gather lint with your hand from the internal parts of the filter.
Throw the lint in the dustbin.

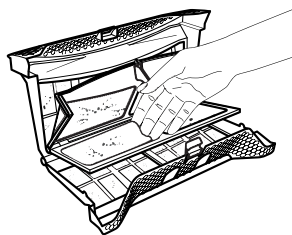

fig.X02248

4. If necessary, clean the filter with a vacuum cleaner. Close the filter.
5. If necessary, remove lint from the filter socket and gasket. You can use a vacuum cleaner. Place the filter back inside the filter socket.

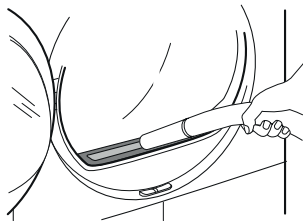



fig.X02229

11.2 Emptying the water container

Empty the condensed water container after each drying cycle.

If the condensed water container is full, the program stops automatically.

The symbol  **Reservoir** appears on the display and you must empty the water container.

To empty the water container:

1. Pull the water container out keeping it in a horizontal position.

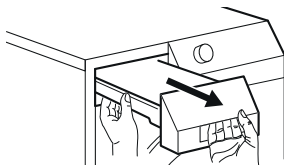

fig.X02230

2. Pull the plastic connection out and drain the water into a basin or equivalent receptacle.

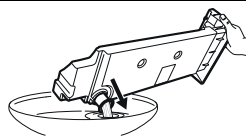



fig.X02231

3. Push the plastic connection back in and place the water container back into position.
4. To continue the program press the **Start/Pause** button.

11.3 Cleaning the condenser

If the symbol  **Condenser** flashes on the display, inspect the condenser and its compartment. If it is dirty, clean it.



Warning



Do not touch the metal surface with bare hands. Risk of injury. Wear protective gloves. Clean carefully to avoid damaging the metal surface.

To inspect:

1. Open the door. Pull the filter up.

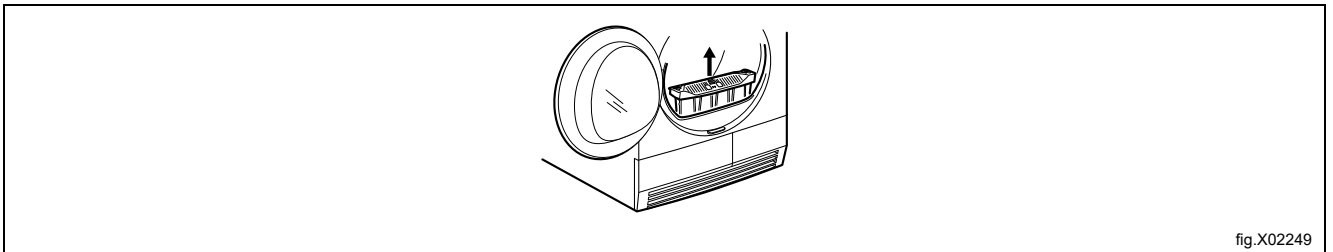

2. Slide the release button on the bottom of the door to open the condenser door.

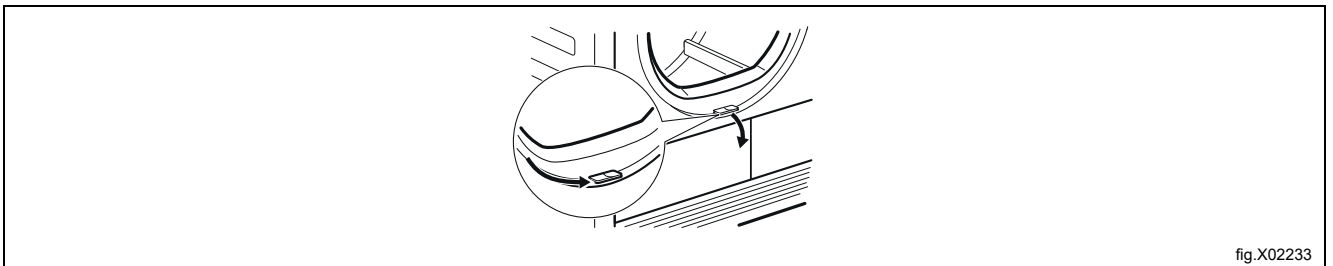

3. Turn the lever to unlock the condenser cover.

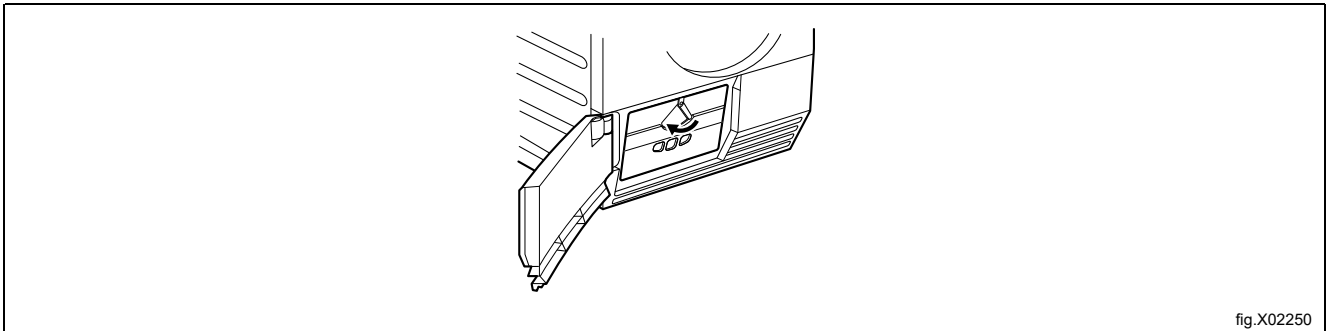

4. Lower the condenser cover.

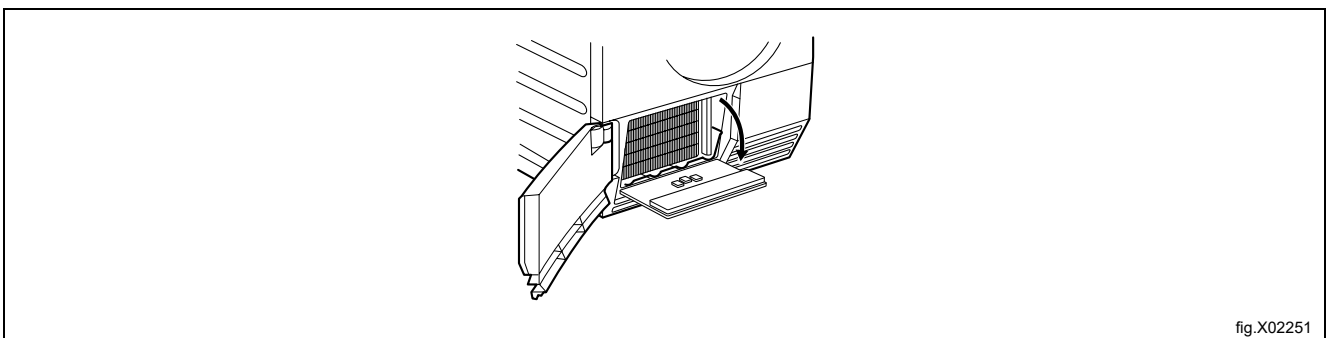

5. If necessary, remove the fluff from the heat exchanger and its compartment. You can use a wet cloth and/or a vacuum cleaner with a brush attachment.

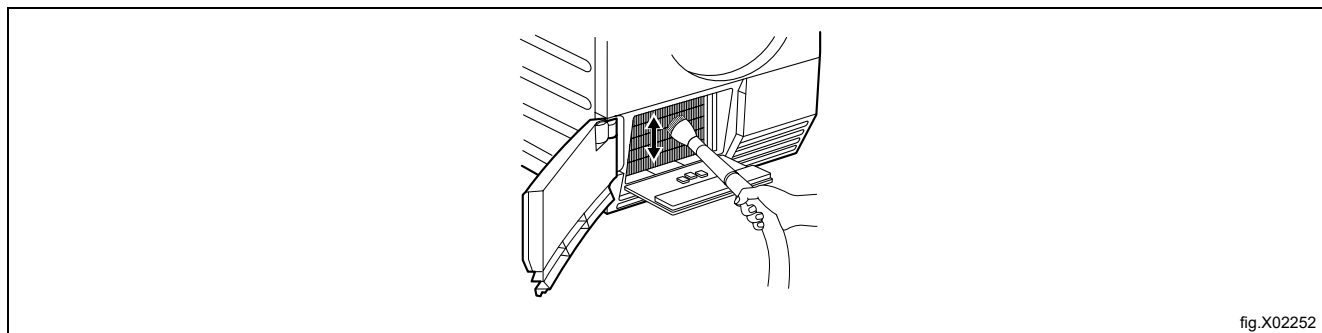

fig.X02252

6. Close the heat exchanger cover.
7. Turn the lever until it clicks into position.
8. Put the filter back.

11.4 Cleaning the humidity sensor



Caution



Risk of humidity sensor damage. Do not use abrasive materials or steel wool to clean the sensor.

To assure best drying results the appliance is equipped with metal humidity sensor. It is placed on the inner side of the door area.

Over usage time the surface of the sensor may get dirty which deteriorates the drying performance.

We recommend to clean the sensor at least 3 or 4 times or if you observe the drop of drying performance.

To clean you can use harder side of dishwashing sponge and bit of vinegar or dish soap.

To clean the sensor:

- Open the loading door.
- Clean the surfaces of the humidity sensor wiping off the metal surface several times.

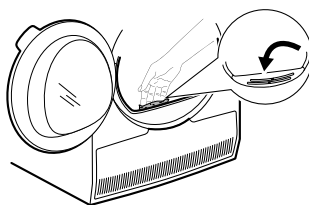

fig.X03361

11.5 Cleaning the drum



Warning



Disconnect the appliance before you clean it.

Use a standard neutral soap detergent to clean the inner surface of the drum and drum lifters. Dry the cleaned surfaces with a soft cloth.



Caution



Do not use abrasive materials or steel wool to clean the drum.

11.6 Cleaning the control panel and housing

Use a standard neutral soap detergent to clean the control panel and housing.
Use a moist cloth to clean. Dry the cleaned surfaces with a soft cloth.



Caution



Do not use furniture cleaning agents or cleaning agents which can cause corrosion to clean the appliance.

11.7 Cleaning the airflow slots

Use a vacuum cleaner to remove the fluff from the airflow slots.

12 Trouble shooting

Problem*	Possible cause	Remedy
The tumble dryer does not operate.	The tumble dryer is not connected to mains supply.	Connect in at mains socket. Check fuse in fuse box (domestic installation).
	The loading door is opened.	Close the loading door.
	The ON/OFF button was not pushed.	Push the ON/OFF button.
	The Start/Pause button was not pushed.	Push the Start/Pause button.
	The appliance is in the standby mode.	Push the ON/OFF button.
	The filter is missing or in wrong position.	Insert the filter in correct position.
	The E10 error code on the display - clogged filter.	Clean the filter.**
	The E59 error code on the display - dryer overloaded.	Unload part of the laundry. Obey the maximum load.
Unsatisfactory drying result.	Incorrect program selection.	Do the selection of the applicable program.***
	The EF0 error code on the display - filter abnormally dirty.	Clean the filter.**
	The filter is clogged.	Clean the filter.**
	Too high volume of the load.	Obey the maximum load volume.
	The airflow grill is clogged.	Clean the airflow grill in the bottom of the appliance.
	Dirt on the humidity sensor in the drum.	Clean the front surface of the drum.
	Incorrect remaining laundry moisture degree.	Adjust remaining laundry moisture degree.****
	The heat exchanger is clogged.	Clean the heat exchanger.**
The loading door does not close.	The filter is not locked in position.	Insert the filter in correct position.
	The laundry is locked between the door and the seal.	Put the load correctly in the drum.
Err (Error) on the display.	You try to change the program or the option after the start of the cycle.	Turn the tumble dryer off and on. Make the new selection.
	The option you try to activate is not applicable with the selected program.	Turn the tumble dryer off and on. Make the new selection.
No drum light.	Defective drum lamp.	Contact the service centre to replace the drum lamp.
Abnormally elapsing time on the display.	The time to end is calculated on the basis of the volume and dampness of the laundry.	The automatic procedure - this is not the appliance malfunction.
Program inactive.	The water container is full.	Drain the water container, push the Start/Pause button. **
Drying cycle too short.	Too small laundry volume.	Do the selection of time program. The time value must be related to the load. To dry one item or small quantities of the laundry, we recommend to use short times.
	The laundry is too dry.	Do the selection of the time program with longer time.
Drying cycle too long. *****	The EF0 error code on the display - filter abnormally dirty.	Clean the filter.**
	The filter is clogged.	Clean the filter.**
	Too high volume of the load.	Obey the maximum load.
	The laundry not spun sufficiently.	Spin the laundry correctly.
	Too low or too high room temperature - this is not the appliance malfunction.	Ensure a room temperature higher than +5°C and lower than +35°C. Optimal room temperature to achieve best drying results is between 19°-24°C.

* If there is an error message on the display (e.g. **E51**): Turn the tumble dryer off and on.

Make a selection of the new program. Push the Start/Pause button. If the tumble dryer still does not operate - contact the service centre and give the error code.

** See chapter: "Care and cleaning".

*** Follow the program description - see chapter: "Programs".

**** See chapter: "Hints and tips".

***** **Note! After maximum 5 hours the drying cycle ends automatically.**

13 Technical data

Height x Width x Depth	850 x 596 x 638 mm (maximal 663 mm)
Max. depth with the appliance door open	1108 mm
Max. width with the appliance door open	958 mm
Adjustable height	850 mm (+ 15 mm - feet regulation)
Drum volume	118 l
Maximum load volume	8.0 kg
Voltage	230 V
Frequency	50 Hz
Sound power level	66 dB
Necessary fuse	5 A
Total power	900 W
Energy efficiency class	A++
Energy consumption on the standard cotton programme with the full load.*	1.99 kWh
Energy consumption on the standard cotton programme with the partial load.**	1.07 kWh
Annual energy consumption***	234.7 kWh
Left-on mode power absorption****	0.13 W
Off mode power absorption****	0.13 W
Type of use	Household and commercial
Allowed ambient temperature	+ 5°C to + 35°C
Level of protection against ingress of solid particles and moisture ensured by the protective cover, except where the low voltage equipment has no protection against moisture	IPX4
This product contains fluorinated greenhouse gases, hermetically sealed	
Gas designation	R134a
Weight	0.30 kg
Global-warming potential (GWP)	1430

* With reference to EN 61121. 8.0 kg of cotton centrifuged at 1000 rpm.

** With reference to EN 61121. 4.0 kg of cotton centrifuged at 1000 rpm.

*** Energy consumption per year in kWh, based on 160 drying cycles of the standard cotton program at full and partial load and the consumption of the low-power modes. Actual energy consumption per cycle will depend on how the appliance is used (REGULATION (EU) No. 392/2012).

****With reference to EN 61121.

The information given in the chart above is compliant with the EU Commission regulation 392/2012 implementing directive 2009/125/EC.

13.1 Product information sheet in reference to E.U. regulation 1369/2017

Trade Mark	Electrolux Professional
Model	TE1120HP PNC 916098429
Rated capacity in kg	8.0
Air vented or condenser tumble dryer	Condenser
Energy efficiency class	A++
Energy consumption in kWh per year, based on 160 drying cycles of the standard cotton program at full and partial load, and the consumption of the low-power modes. Actual energy consumption per cycle will depend on how the appliance is used.	234.7
Automatic tumble dryer or non-automatic tumble dryer	Automatic
Energy consumption of the standard cotton program at full load in kWh	1.99
Energy consumption of the standard cotton program at partial load in kWh	1.07
Power consumption of the off-mode in W	0.13
Power consumption in left-on mode in W	0.13
Duration of the left on mode in minutes	10
The 'standard cotton program' used at full and partial load is the standard drying program to which the information in the label and the fiche relates, this program is suitable for drying normal wet cotton laundry and it is the most efficient program in terms of energy consumption for cotton.	
Weighted program time of the 'standard cotton program at full and partial load' in minutes	117
Program time of the 'standard cotton program at full load' in minutes	154
Program time of the 'standard cotton program at partial load' in minutes	89
Condensation efficiency class on a scale from G (least efficient) to A (most efficient)	B
Average condensation efficiency of the standard cotton program at full load as a percentage	82
Average condensation efficiency of the standard cotton program at partial load as a percentage	82
Weighted condensation efficiency for the 'standard cotton program at full and partial load'	82
Sound power level in dB	66
Built in appliance Y/N	No

14 Disposal information

14.1 Disposal of appliance at end of life

Before disposing of the machine, make sure to carefully check its physical condition, and in particular any parts of the structure that can give or break during scrapping.

The machine's parts must be disposed of in a differentiated way, according to their different characteristics (e.g. metals, oils, greases, plastic, rubber, etc.).

Different regulations are in force in the various countries, therefore comply with the provisions of the laws and competent bodies in the country where scrapping takes place.

In general, the appliance must be taken to a specialised collection/scrapping centre.

Dismantle the appliance, grouping the components according to their chemical characteristics, remembering that the compressor contains lubricant oil and refrigerant fluid which can be recycled, and that the refrigerator and heat pump components are special waste assimilable with urban waste.

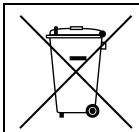

The symbol on the product indicates that this product should not be treated as domestic waste, but must be correctly disposed of in order to prevent any negative consequences for the environment and human health. For further information on the recycling of this product, contact the local dealer or agent, the Customer Care service or the local body responsible for waste disposal.



Note!

When scrapping the machine, any marking, this manual and other documents concerning the appliance must be destroyed.

14.2 Disposal of packing

The packing must be disposed of in compliance with the current regulations in the country where the appliance is used. All the packing materials are environmentally friendly.

They can be safely kept, recycled or burned in an appropriate waste incineration plant. Recyclable plastic parts are marked as following examples.

	Polyethylene: <ul style="list-style-type: none"> • Outer wrapping • Instructions bag
	Polypropylene: <ul style="list-style-type: none"> • Straps
	Polystyrene foam: <ul style="list-style-type: none"> • Corner protectors



Electrolux Professional AB
341 80 Ljungby, Sweden
www.electroluxprofessional.com